



BULLWORTHY

THE GARAGE EQUIPMENT SPECIALISTS

FOUR POST MOT LIFTS



TECHNIQUE

4400.1/3IMOT4

LOW PROFILE 130mm - 4 TONNE

Four tonne four post electro-hydraulic lift, Class 4 ATL/OPTL. This lift has been specifically designed to fit perfectly into existing MOT pits.

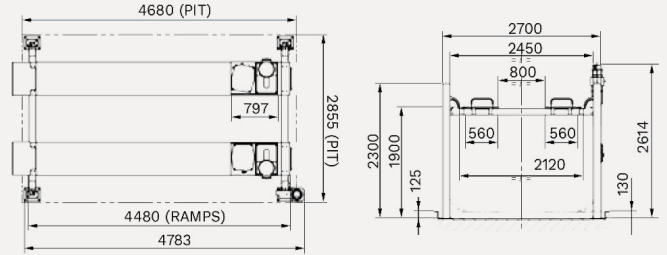
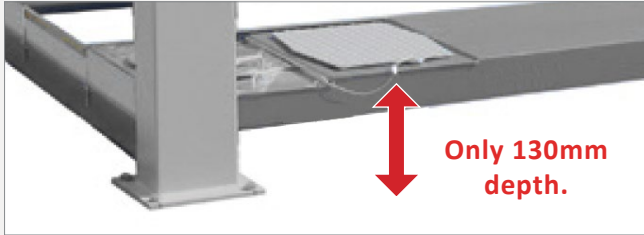

MODEL	CAPACITY	HEIGHT LOWERED	PLATFORM WIDTH	PLATFORM LENGTH
4400.1IMOT4	4.0T	130mm	560mm	4480mm
4400.3IMOT4	4.0T	130mm	560mm	4480mm



TECHNIQUE

4401.1/3IMOT4

LOW PROFILE 160mm - 4 TONNE

4 tonne four post electro-hydraulic lift, Class 4 ATL/OPT.

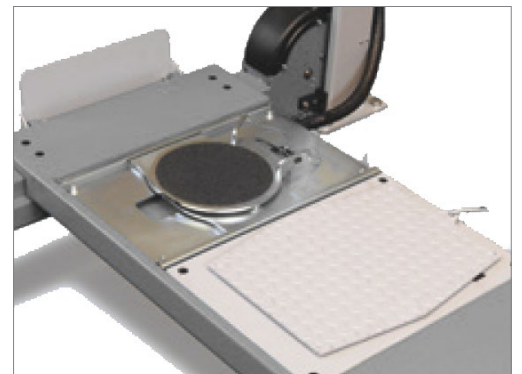
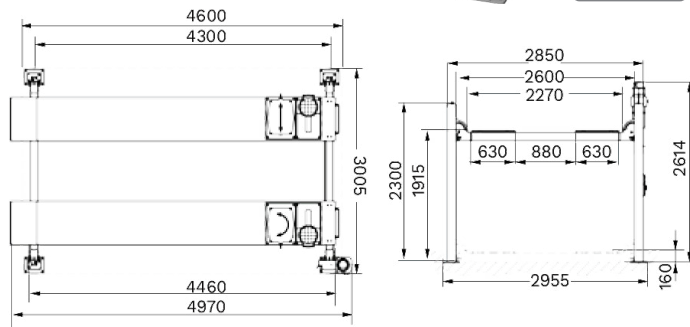

MODEL	CAPACITY	HEIGHT LOWERED	PLATFORM WIDTH	PLATFORM LENGTH
4401.1IMOT4	4.0T	160mm	560mm	4480mm
4401.3IMOT4	4.0T	160mm	560mm	4480mm

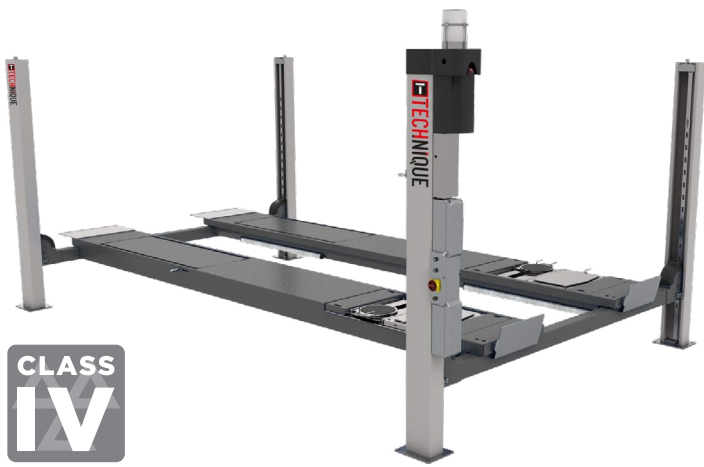

CLASS IV

TECHNIQUE

4406.3IMOT4

MOT ALIGNMENT WITH BUILT-IN REAR SLIP PLATES

4 tonne four post electro-hydraulic lift, Class 4 ATL/OPTL. MOT alignment lift with built-in rear slip plates.

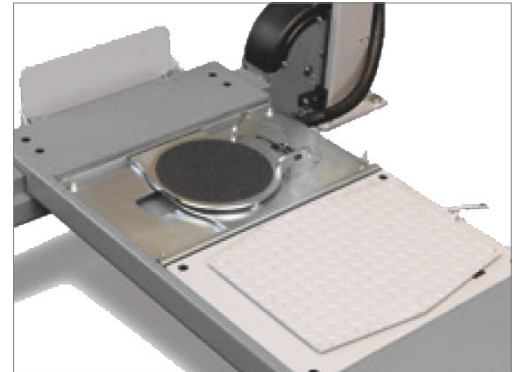
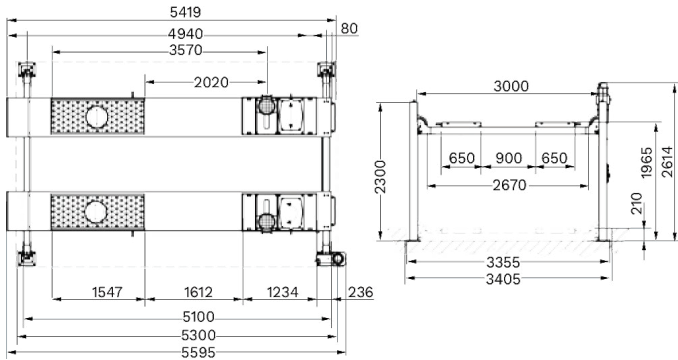

MODEL	CAPACITY	HEIGHT LOWERED	PLATFORM WIDTH	PLATFORM LENGTH
4406.3IMOT4	4.0T	210mm	650mm	5100mm

TECHNIQUE

4500.3IMOT7 4502.3IMOT7

CLASS VII

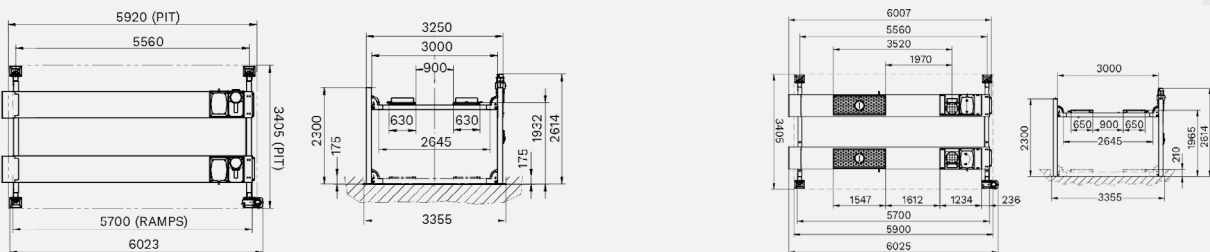

4500.3IMOT7 - Five tonne Class 7 ATL/OPTL four post electro-hydraulic lift.

4502.3IMOT7 - Five tonne Class 7 four post electro-hydraulic lift complete with built-in rear slip plates.

MODEL	CAPACITY	HEIGHT LOWERED	PLATFORM WIDTH	PLATFORM LENGTH
4500.3IMOT7	5.0T	175mm	650mm	5700mm
4502.3IMOT7	5.0T	175mm	650mm	5700mm

STAY ON TRACK

TTECHNIQUE



BULLWORTHY
THE GARAGE EQUIPMENT SPECIALISTS

MAIN OFFICE: UNIT 7, MANOR BUSINESS PARK, WOODFORD HALSE, NORTHAMPTONSHIRE, NN11 3UB.



(01295) 768373



enquiries@bullworthy.co.uk



www.bullworthy.co.uk